



NORTH POINT CABINETS, LLC

2021 Catalog

Macias
CABINETS, LLC
AUTHORIZED DEALER

NorthPoint Cabinetry boasts a wide array of high-quality cabinet combinations allowing you to design the perfect kitchen or bath that works for your family’s lifestyle. Make the kitchen or bath high-functioning and stunningly beautiful by adding Hardware Resources’ vast selection of cabinet organizers, LED cabinet lighting, and knobs and pulls.

NorthPoint Cabinetry is an industry-leading brand of Dimora Brands, which also includes Top Knobs, Atlas Homewares, Watermark Designs, Water Street Brass, Vesta Fine Hardware, Task Lighting, Jeffrey Alexander, Elements, and Hardware Resources. As such, you can expect high-quality products, fast delivery, and excellent customer service.

Table of Contents

Our Collections	2-3
Quality Comes First.	4-7
Expert Finishing	8
Our Door Styles	
Catalina	12-19
Maui	20-27
Hatteras.	28-33
Versatile Vanity Cabinets.	34-37
Cabinets for Any Space	38-41
Personalize Your Space	
Moulding	42-43
Fillers & Panels.	44-45
Design Elements.	46-47
Specialty Cabinets.	48-49
The Finishing Touches	
Decorative Cabinet Hardware	52-59
Cabinet Organizers	60-67
Stainless Steel Sinks.	68-69
Cabinet Lighting	70-75
Manufacturing & Technical Information	
Cabinet Breakdown	76-77
Cabinet Lineup.	78-79
Ordering Information	80
Warranty	81
Care & Cleaning	81



Cabinets: Maui Polar White

Island: Maui Espresso

Decorative Cabinet Hardware: Zane Collection in Satin Nickel

Our Collections



PREMIER Collection

Pages 12 – 27

The Premier Collection features elegant upgrades like soft-close doors and drawers.

Door Styles: Catalina, Maui

- 3/4" Solid Wood Face Frame
- 1/2" Plywood Cabinet Construction
- Premium 100% Water-based Finishes
- Beautiful, finished interior
- 5-year Limited Lifetime Warranty

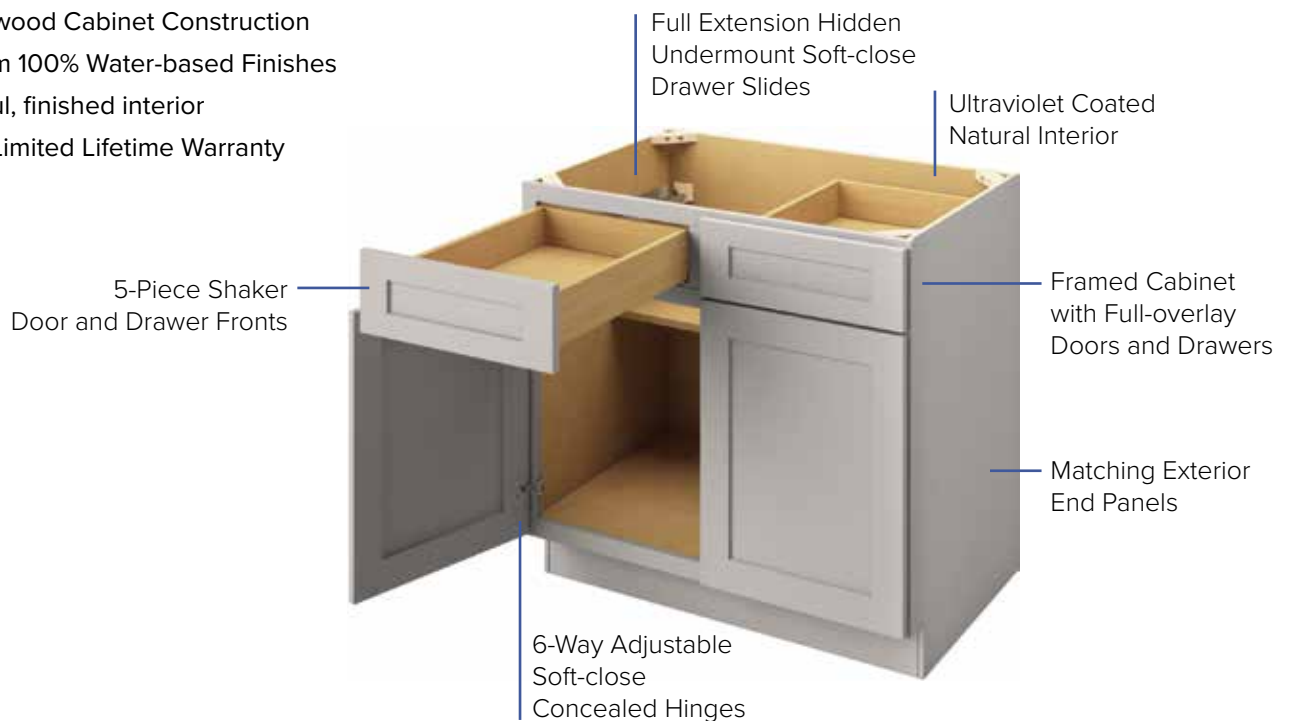



ESSENTIALS

Collection

Pages 28 – 33

The Essentials Collection delivers on style at an impressive value.

Door Style: Hatteras

- 3/4" Solid Wood Face Frame
- 1/2" Plywood Cabinet Construction
- Premium 100% Water-based Finishes
- Beautiful, finished interior
- 1-year Limited Lifetime Warranty

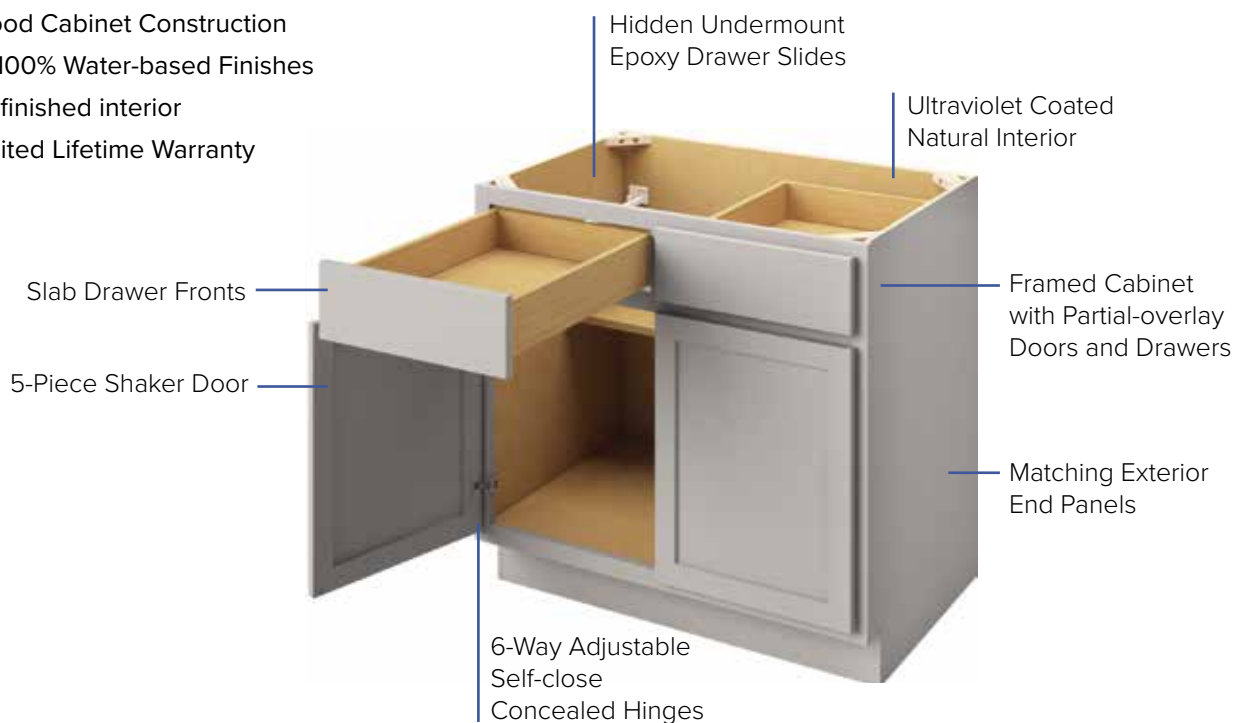

Quality Comes First

Your choice of cabinetry makes a personality-defining statement in your home. Selecting the right cabinets is an important first step because your cabinets should be just as functional on the inside as they are beautiful on the outside. Cabinets should withstand the demands of daily use, and maintain their integrity throughout their lifetime.

That's why quality comes first at NorthPoint Cabinetry. Every detail is carefully considered to ensure our cabinets not only meet our high-quality standards, but yours as well. Our commitment to quality combined with our on-trend finishes, door styles and product depth and breadth are what make NorthPoint Cabinetry the perfect choice for your project.

It Starts with Quality Wood

Just as a healthy tree needs strong roots to thrive, so too does a quality cabinet require premium lumber at its core. Our cabinets feature a **solid wood construction**, so the quality of wood is of utmost importance.



Structural Integrity

Meaningful yet hidden reinforcements, like solid wood corner blocks and strategically placed pocket screws, help reinforce the structural integrity of the cabinet. Take comfort that these well-constructed cabinets will stand the test of time.

Thoughtful Craftsmanship

Boasting an innovative dovetail and hidden pocket screw construction, these cleverly designed cabinets result in robust quality and quick, accurate assembly.





Pretty on the Inside Too

NorthPoint Cabinetry features a clean and beautifully finished birch interior that enhances the cabinet's luxurious, high-quality appeal.

Premium Drawer Boxes

Dovetail joinery is the hallmark of high-quality drawer boxes. The finished interior of the drawer boxes coupled with the dovetail construction, and silky-smooth concealed slides make this drawer box the star of the show.





Hardworking Hardware

Our cabinets feature discreet compact hinges and concealed undermount slides. The hinges & slides have been 3rd party tested and exceed industry standards. The Premier collection (shown) features full extension slides so that you can easily access and make use of the whole drawer.

Sturdy Shelves

NorthPoint Cabinetry shelves are constructed from an impressive $\frac{3}{4}$ " thick, veneered plywood. This means that you don't have to worry about shelves sagging under pressure of normal use. Shelf height is adjustable so that you can optimize storage space for your needs.



Expert Finishing

Count on consistent, high-quality finishing. Our state-of-the-art manufacturing facility utilizes a multi-step professional finishing process. This meticulous process guarantees that finishes maintain a high degree of color and application accuracy from cabinet to cabinet, which means that your cabinets will look stunning.

Our cabinets and accessories feature water-based ultraviolet (UV) finishes. Water-based UV finishes emit low Volatile Organic Compounds (VOCs) and are environmentally responsible. Ultraviolet finishing uses light instead of heat for curing and the benefits include no environmental pollutants or solvents to evaporate, increased chemical resistance and durability.



ESPRESSO



SLATE

Coming Summer 2021



PEBBLE GREY



POLAR WHITE

Premium Multi-Step Finishing Process

1. The finest wood components are sanded with precision
2. A balanced base coat is applied to ensure a consistent, quality finish
3. First stage ultraviolet (UV) curing process occurs
4. The wood is finely sanded and vacuumed
5. A tinted primer is applied as a foundation for our superior finish
6. Second stage (UV) curing
7. The wood is finely sanded and vacuumed
8. The solid paint layer is evenly applied
9. Third stage (UV) curing
10. The wood is finely sanded and vacuumed
11. First layer of water based clear coat is applied
12. The components go through the dryer to prepare for final processing
13. The wood is finely sanded and vacuumed
14. Second layer of water-based clear coat is applied
15. The components go through the dryer once again
16. Final sanding for a smooth surface and vacuumed for a thorough cleaning
17. A final layer of topcoat is evenly applied
18. Oven cured for catalyzed hardened finish
19. Visual inspection with a color consistency examination performed

Process for stained products varies slightly from the above steps.



Product Depth & Breadth

Our comprehensive line of 2,100 kitchen cabinets and accessories can accommodate almost any kitchen or bathroom layout.

Personalize your cabinets with cabinet organizers, cabinet lighting, and knobs and pulls offered through NorthPoint Cabinetry's sister brands - Hardware Resources, Jeffrey Alexander, Elements, Task Lighting.

DOOR STYLES

CATALINA

Premier Collection

More than modern.
The Catalina door style features
a full-overlay, Shaker style door
and 5-piece drawer front.

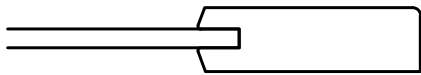

Pebble Grey

MAUI

Premier Collection

Sometimes the details make all
the difference. The Maui door style
features a full-overlay, transitional
door and 5-piece drawer front
with a twist of character.



Pebble Grey

HATTERAS

Essentials Collection

Simple and sleek.
The Hatteras door style features
a partial-overlay, Shaker style
door and slab drawer front.

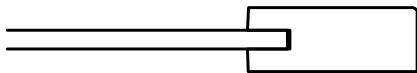

Pebble Grey

Maui
in stained
Espresso

Catalina in
stained Slate
Coming Summer 2021

Maui
in painted
Pebble Grey

Hatteras
in painted
Polar White

PREMIER COLLECTION: CATALINA



CATALINA

POLAR WHITE
FINISH

**NORTH
POINT**
CABINETS®



Decorative Cabinet Hardware: Pulls - Merrick Collection in Matte Black
Knobs - Sonoma Collection in Matte Black



PREMIER COLLECTION: CATALINA



CATALINA

SLATE
FINISH

Coming Summer 2021

**NORTH
POINT**
CABINETS®



Decorative Cabinet Hardware: Dominique Collection in Satin Bronze



PREMIER COLLECTION: CATALINA



CATALINA

PEBBLE GREY
FINISH

**NORTH
POINT**
CABINETS®



Decorative Cabinet Hardware: Katharine Collection in Brushed Pewter



PREMIER COLLECTION: CATALINA



CATALINA

ESPRESSO
FINISH

*Wall cabinets shown
in Catalina Polar White*

**NORTH
POINT**
CABINETS®



Decorative Cabinet Hardware: Tiffany Collection in Satin Bronze



PREMIER COLLECTION: MAUI



MAUI

POLAR WHITE FINISH

*Island cabinets shown
in Maui Espresso*



**NORTH
POINT**
CABINETS[®]

Decorative Cabinet Hardware: Knox Collection in Satin Nickel



PREMIER COLLECTION: MAUI



MAUI

SLATE
FINISH

Coming Summer 2021

*Island cabinets shown
in Maui Polar White*

**NORTH
POINT**
CABINETS®



Decorative Cabinet Hardware: Belcastel 1 Collection in Matte Black



PREMIER COLLECTION: MAUI



MAUI

PEBBLE GREY FINISH

*Island cabinets shown
in Maui Espresso*



**NORTH
POINT**
CABINETS[®]

Decorative Cabinet Hardware: Boswell Collection in Matte Black



PREMIER COLLECTION: MAUI



MAUI

ESPRESSO FINISH

*Island cabinets shown
in Maui Polar White*

**NORTH
POINT**
CABINETS[®]



Decorative Cabinet Hardware: Leyton Collection in Satin Nickel



ESSENTIALS COLLECTION: HATTERAS



HATTERAS

POLAR WHITE FINISH

*Island cabinets shown
in Hatteras Pebble Grey*

**NORTH
POINT**
CABINETS[®]



Decorative Cabinet Hardware: Naples Collection in Brushed Gold



ESSENTIALS COLLECTION: HATTERAS



HATTERAS

PEBBLE GREY
FINISH

**NORTH
POINT**
CABINETS®



Decorative Cabinet Hardware: Shown in Matte Black



ESSENTIALS COLLECTION: HATTERAS



HATTERAS

ESPRESSO
FINISH

**NORTH
POINT**
CABINETS®



Decorative Cabinet Hardware: Sutton Collection in Polished Chrome



Versatile Vanity Cabinets

Our kitchen and vanity cabinets are made with the same dependable quality and construction. The vanity door styles and finishes match our kitchen cabinet collections, which allows you to thoughtfully coordinate your spaces, creating an intelligent design flow from kitchen to bathroom, or mix up the design styles and finishes from room to room if that best fits your design personality.

We offer many different vanity cabinet configurations allowing our cabinets to perfectly fit most bathroom spaces. Options like linen cabinets and all drawer cabinets go the extra mile to make the bathroom space functional and beautiful.



Catalina Polar White Cabinets

Decorative Cabinet Hardware: Tahoe Collection in Matte Black



Catalina Polar White Cabinets
Decorative Cabinet Hardware:
Cordova in Satin Nickel





Maui Espresso Cabinets
Decorative Cabinet Hardware: Bremen 2 in Gun Metal



Maui Pebble Grey Cabinets
Decorative Cabinet Hardware: Marie in Satin Bronze

Cabinets for Any Space

The kitchen and bath are common spaces to install cabinetry. However, you can enhance your other spaces like the laundry room, mudroom, and entertainment areas with NorthPoint Cabinetry. Cabinets make those spaces more functional by providing additional storage or countertop work space.



Wine Bar

Catalina Pebble Grey Cabinets
Decorative Cabinet Hardware: Marlo in Satin Nickel



Mudroom

Maui Polar White Cabinets
Decorative Cabinet Hardware:
Ella Collection in Brushed Oil
Rubbed Bronze
Decorative Hooks:
Emerald Backplate in
Brushed Oil Rubbed Bronze



Laundry Room

Catalina Slate Cabinets
Coming Summer 2021
Decorative Cabinet Hardware:
Hudson Collection
in Satin Nickel

Butler's Pantry

Catalina Polar White Cabinets
Decorative Cabinet Hardware:
Wheeler Collection in Matte Black





Closet

Catalina Pebble Grey Cabinets
Decorative Cabinet Hardware: Merrick Collection in Satin Nickel



Entertainment Center

Maui Espresso Cabinets
Decorative Cabinet Hardware: Rae Collection in Satin Nickel

Personalize Your Space - Moulding

Add the finishing touch to your cabinets with our broad selection of finished mouldings. Light rail moulding allows under cabinet task lighting to be neatly tucked out of sight, while our selection of crown mouldings, from cove to classic, add a level of beauty and sophistication to the room. We offer many different types of decorative and utility mouldings in all finishes to accentuate and complete the space.

LIGHT RAIL

Available in all finishes:
Polar White, Pebble Grey,
Espresso & Slate



FINISH MOULDINGS

Available in all finishes: Polar White, Pebble Grey, Espresso & Slate





Cove Crown Look



Angled Crown Look



Classic Crown Look



Personalize Your Space - Fillers & Panels

We offer a variety of fluted and standard, overlay fillers, and decorative end panels to help complete the cabinets with style. Create smooth transitions in cabinet layouts with fillers. Use decorative end panels to add character and a finish touch to your design. Utility panels, like refrigerator end panels, dishwasher end panels, and island back panels accommodate endless kitchen layouts.

More options available. See our Specification Guide for complete offering.



FLUTED FILLER

3/4" Thick Material

Available in all finishes:
Polar White, Pebble Grey,
Espresso & Slate

BEADBOARD PANELS

1/4" Thick Material

Available in all finishes:
Polar White, Pebble Grey,
Espresso & Slate





WALL, BASE & REFRIGERATOR END PANELS

Available in all finishes:
Polar White, Pebble Grey,
Espresso & Slate

DECORATIVE END PANELS

Available in all finishes & door styles:
Polar White, Pebble Grey,
Espresso & Slate



Personalize Your Space - Design Elements

Your cabinets should reflect your style. Our wide variety of decorative wood accessories add a touch of character to the cabinet design. Whether your ideal space is traditional, transitional or contemporary, we have the selection available to transform the space from “blah” to “ahhh!” *More options available. See our Specification Guide for complete offering.*



CORBELS

Available in all finishes:
Polar White, Pebble Grey, Espresso & Slate



DECORATIVE LEGS

Available in all finishes:
Polar White, Pebble Grey,
Espresso & Slate





BUN & TAPERED FEET

Available in all finishes:
Polar White, Pebble Grey,
Espresso & Slate



SCALLOPED OR ARCHED VALANCE

Available in all finishes:
Polar White, Pebble Grey,
Espresso & Slate



Personalize Your Space - Specialty Cabinets

Our wide selection of specialty cabinets expands the functionality to fit your lifestyle. Whether you need an elegant storage solution for your bottles of wine or want a space to display your trendy decorative plates, we have the solutions that work for you. *More options available. See our Specification Guide for complete offering.*



Wine Rack



Plate Rack



Microwave Wall Cabinet



Microwave Base Cabinet





RANGE HOODS

Available in all finishes:
Polar White, Pebble Grey,
Espresso & Slate

FARMHOUSE SINK BASE CABINET

Available in all finishes & door styles:
Polar White, Pebble Grey,
Espresso & Slate



GLASS DOOR CABINETS

Only available in the Premier collection
door styles, Catalina & Maui

Available in all finishes:
Polar White, Pebble Grey, Espresso & Slate

Cabinets come with matching interiors and
a clear glass center panel

The Finishing Touches

Knobs & Pulls • Organizers
Cabinet Lighting • Hidden Power • Sinks





Knobs & Pulls

JEFFREY ALEXANDER®
by Hardware Resources

E L E M E N T S®
by Hardware Resources

Add the perfect finishing touch to your NorthPoint Cabinets with Jeffrey Alexander and Elements cabinet knobs and pulls! We know every detail you choose plays a role in personalizing your space, really bringing it to life. Cabinet knobs and pulls often take center stage by adding the finishing touch on the perfect design.

We watch trends, listen to our customers, and get inspired! Inspiration is found everywhere from fashion to architecture to jewelry, influencing our design team to create products that aid in expressing one's style in the home. **There are 100s of different knobs and pulls to choose from** in various sizes, options, and price points so that you can achieve that perfect look.



Satin Nickel Pulls

Jeffrey Alexander Leyton Collection
Maui Espresso Cabinets



For more information on
Knobs & Pulls, scan the QR code
or visit <https://delivr.com/2fk7w>



Matte Black Pulls
Jeffrey Alexander Wheeler Collection
Catalina Polar White Cabinets



Satin Bronze Pulls
Elements Thatcher Collection
Catalina Espresso Cabinets



Brushed Gold Pulls
Elements Naples Collection
Hatteras Polar White Cabinets

Popular Styles in Satin Nickel



Belcastel Collection



Boswell Collection



Dominique Collection



Florence Collection



Glendale Collection



Hadly Collection



Hayworth Collection



Kenner Collection



Knox Collection



Madison Collection



Merrick Collection



Naples Collection



Roman Collection



Somerset Collection



Stanton Collection



Sullivan Collection



Sutton Collection



Thatcher Collection



Tiffany Collection

Popular Styles in Polished Chrome



Belcastel Collection



Boswell Collection



Dominique Collection



Florence Collection



Glendale Collection



Hadly Collection



Hayworth Collection



Kenner Collection



Knox Collection



Madison Collection



Merrick Collection



Naples Collection



Roman Collection



Somerset Collection



Stanton Collection



Sullivan Collection



Sutton Collection



Thatcher Collection



Tiffany Collection

To see more styles, lengths, and finishes, visit www.HardwareResources.com for more information.



**NORTH
POINT**
CABINETS®

Popular Styles in Matte Black



Belcastel Collection



Boswell Collection



Dominique Collection



Florence Collection



Glendale Collection



Hadly Collection



Hayworth Collection



Kenner Collection



Knox Collection



Madison Collection



Merrick Collection



Naples Collection



Roman Collection



Somerset Collection



Stanton Collection



Sullivan Collection



Sutton Collection



Thatcher Collection

Popular Styles in Satin Bronze



Belcastel Collection



Dominique Collection



Florence Collection



Glendale Collection



Hadly Collection



Hayworth Collection



Madison Collection



Merrick Collection



Naples Collection



Roman Collection



Somerset Collection



Stanton Collection



Sutton Collection



Thatcher Collection



Tiffany Collection

To see more styles, lengths, and finishes, visit www.HardwareResources.com for more information.



Long Cabinet Pulls Look Best

Cabinet knobs and pulls come in a variety of sizes, styles and finishes. But which ones should you choose?

You could decide to use all cabinet pulls. Or you may prefer the look of all cabinet knobs. Or you can mix knobs and pulls in your kitchen. Which one is right? They all are. All it comes down to is your personal preference.

Best Look



To achieve a cohesive & finished look, select a pull that's proportional in length to the cabinet door or drawer. Shorter doors & drawers use shorter pulls; longer doors & drawers use longer pulls.

Better Look



Catalina Pebble Grey Cabinets
Decorative Cabinet Hardware: Roman Collection in Matte Black

Good Look



Catalina Pebble Grey Cabinets
Decorative Cabinet Hardware: Roman Collection in Matte Black



For more information on
selecting knobs & pulls,
scan the QR code or visit
<https://delivr.com/2fk7w>

Create an Organized & Efficient Kitchen

Select cabinet organizers to conquer clutter. Organize kitchen essentials and put them at your fingertips. No more reaching!

Neatly Tuck Away Trash Cans

Pick a trash can solution that best fits your kitchen and your budget.

- Wood Bottom Mount Trash Can
- Economy Soft-Close Trash Can
- Storage with Style® "No Wiggle" Trash Can Pullout



Organization Within Reach

Maximize cabinet storage with base cabinet organizers. Choose pullout organizers to maximize storage and eliminate the reach.

- "No Wiggle" Base Pullout
- Mixer Lift
- Storage with Style® Base Pullout



For more information on cabinet organizers, scan the QR code or visit <https://delivr.com/272ju>



Corner Storage That Comes To You

Bring the deep recesses of corner cabinets forward with corner organizers.

- Easy 360 Susan
- Half Moon Lazy Susan
- Storage with Style® Blind Corner Pullout

Tame Drawer Clutter

Drawer inserts help organize everything from cutlery to spices to dishes.

- Cutlery Drawer Insert
- Spice Rack Drawer Insert
- Peg Board Drawer Insert



Organize Heavily Used Cabinets

From disorder to order, with solutions for challenging storage areas.

- Easy Access Pantry Pullout
- Tray & Cookie Sheet Dividers
- Storage with Style® Pullout Baskets

See the NorthPoint Cabinetry Specification Guide to determine which organizers fit in each cabinet.

Organize Your Whole Kitchen





For more information
on cabinet organizers,
scan the QR code or visit
<https://delivr.com/272ju>

Storage with Style[®] Organizer Collection

Storage solutions that beautifully coordinate to create a harmonious kitchen design



Design is in the details

Curved flat wire design details flow across all organizers to create a cohesive collection identity

Stylish finish options

Designer finishes of Black Nickel & Polished Chrome coordinate with popular hardware styles, or mix finishes to add variety





Storage with Style® Trash Can Pullout



Storage with Style® Base Pullout



Storage with Style® Drawer Base Pullout



Storage with Style® Utensil Pullout



Storage with Style® Blind Corner Pullout



Storage with Style® Pot & Lid Pullout



Storage with Style® Pullout Baskets



For more information on cabinet organizers, scan the QR code or visit <https://delivr.com/272ju>



NORTH POINT
CABINETS

Organize the Bathroom

An organized bathroom is just as important as an organized kitchen. Getting ready for the day in an organized bathroom helps to eliminate stress and save time. These organizers will help transform any bathroom into your dream spa oasis.



1 *Drawer Inserts*

Our drawer inserts aren't just for the kitchen. Repurpose a cutlery organizer for makeup or personal grooming items or use a spice drawer insert to keep nail polish organized.

Fits in 18" and 24" wide drawers

2 *Towel Rack*

Add a designated spot to hold hand towels hidden away in the cabinet with a door mountable towel rack. Tiered design allows for free air movement to help dry damp towels.

Fits in 18" wide cabinets or larger

3 *Rollout Drawers*

Add convenience of a drawer to any cabinet with our soft-close rollouts. Beautiful solid wood birch rollouts match cabinet interiors. Rollout drawers can be added to cabinet bottom and/or cabinet shelf.

Available to fit 15" – 36" wide cabinets



Catalina Polar White Cabinets

Decorative Cabinet Hardware: Tahoe Collection in Matte Black

4 *Door Mounted Rack*

A door mounted rack in a bathroom vanity can keep bottles of beauty products and cans of spray tidy.

Fits in 15" – 21" wide cabinets

5 *"No Wiggle" Vanity Pullout*

Customize your bathroom storage with a vanity pullout featuring premium soft-close undermount slides. The unit's shortened height and depth is designed to fit into bathroom vanity cabinets. A modular design allows for the addition of an optional grooming organizer or acrylic tray divider.

Fits in 12" wide vanity cabinets, requires a full height vanity base cabinet if using optional grooming insert



For more information
on cabinet organizers,
scan the QR code or visit
<https://delivr.com/272ju>

**NORTH
POINT**
CABINERY®

Everything and the Kitchen Sink

The sink is an often overlooked focal point in the home. Preparing a chef-inspired meal for the family or giving the dog a well-needed bath in the laundry room are just a few times a sink is gathered around each day with purpose. Not only does a sink need to hold up against everyday life, but it should also add a look of sophistication and elegance to a room.

Hardware Resources is proud to offer a line of Stainless Steel Kitchen, Bar and Utility sinks for the everyday home. We offer a variety of top sizes and styles of sinks, all manufactured from the highest quality materials.





Add Lighting to Brighten Your Kitchen



Highlight the beauty of your home with LED lighting from Task Lighting. Select between a variety of assembled linear fixtures, tape lighting, puck lights, or specialty lighting to set the mood in any room.



1 *Illuminate countertops with Under Cabinet Lighting*

Illuminate countertops with under cabinet lighting to enhance functional spaces, highlight beautiful backsplashes, or eliminate shadows created from cabinets. Under cabinet lighting creates ample illumination for meal prep and reading recipes.

2 *Accentuate decorative items on display with In Cabinet Lighting*

Use lighting in glass-faced cabinets to accentuate decorative items on display or beautiful crystal and china. Adding lighting inside a glass door cabinet gives a nice wash of light throughout the cabinet.

3 *Highlight beautiful flooring with Toe Kick Lighting*

Add lighting under the toe kick to highlight beautiful flooring during the daytime. At night, keep floors safely illuminated with a gentle glow for midnight snacking.

4 *Add ambiance and make the space feel larger with Above Cabinet Lighting*

Add depth and ambiance to your kitchen by highlighting the open space above cabinets to increase the aesthetic appeal and make the space feel larger.



BEFORE



Catalina Pebble Grey Cabinets

AFTER



Catalina Pebble Grey Cabinets



For more information on Task Lighting products, scan the QR code or visit <https://delivr.com/2eqnz>

Select the Perfect White Color Temperature for Lighting Any Space

When installing lighting, it's important to select an optimal white color (Kelvin) temperature that accentuates the beauty of the space. Pro tip: Using the same color temperature lighting throughout a room gives it a clean, even feel.

Warm White - 2700K



Soft White - 3000K



Cool White - 4000K



Daylight White - 5000K



Or...Use TandemLED™ Lighting to Easily Change the White Color Temp Any Time!



Install TandemLED lighting to experience full tuning control of the white color temperature, from Warm White to Daylight White and all shades of white in between.



Using the wireless controller, adjust the color temperature of TandemLED lighting at any point throughout the day to match the natural lighting outside. A routine can also be set up in a Smart Home system's app to mimic the natural outdoor lighting throughout the day automatically.



.....
○

“Alexa, tune the kitchen to Warm White”

OPTION: Control lights with Amazon Alexa, Google Home, Philips Hue, Apple HomeKit, or any Zigbee 3.0 compatible system.

Google Home Apple HomeKit amazon alexa®



For more information on TandemLED products, scan the QR code or visit <https://delivr.com/2eqnz>

5 YEAR
WARRANTY



PATENTED
10,721,801

**NORTH
POINT**
CABINETS®

Hide Unsightly Power Outlets



Angle Power Strip fixtures tuck away hidden power right where you need it and are the perfect alternative to standard outlets that disrupt the beauty of your glass, tile, or solid-surface backsplash or kitchen island.



18" Black fixture* with USB charging outlets



18" Satin Nickel fixture* with USB charging outlets



18" Bronze fixture* with USB charging outlets



18" White fixture* with USB charging outlets

MADE IN THE
USA

UL LISTED

5 YEAR
WARRANTY



For more information on Angle Power Strip fixtures, scan the QR code or visit www.TaskLighting.com

**Available in standard lengths from 9" to 72"; custom options available*



Tucked away electrical power, plus switches to control lighting, garbage disposal

Tuck under the island countertop for easy hidden power

Lighted Power Strip
Combines LED lighting and angled power outlets

ASSEMBLED
IN THE
USA

Hatteras Polar White Cabinets, Hatteras Pebble Grey Island
Decorative Cabinet Hardware: Naples Collection in Brushed Gold



Angle Power Strip tucked up under the cabinet preserving the backsplash (and "disappears" when standing)

**PRESERVE THE BEAUTY OF THE BACKSPLASH & ISLAND
WITH TUCKED AWAY POWER**



Cabinetry Technical Information

DOOR STYLES	PREMIER Collection Catalina, Maui	ESSENTIALS Collection Hatteras
A OVERLAY	<ul style="list-style-type: none"> • Full-overlay doors and drawer fronts 	<ul style="list-style-type: none"> • Partial-overlay doors and drawer fronts
B FACE FRAME	<ul style="list-style-type: none"> • 3/4" (19 mm) x 1-1/2" (36 mm) solid birch face frame 	<ul style="list-style-type: none"> • 3/4" (19 mm) x 1-1/2" (36 mm) solid birch face frame
C DOORS	<ul style="list-style-type: none"> • Stained doors are 5-piece birch solid wood cope-and-stick construction with a 3/4" (19 mm) thick, 2-3/4" wide door frame and 1/4" veneered center panel • Painted doors are 5-piece MDF cope-and-stick with a 3/4" (19 mm) thick, 2-3/4" wide door frame with 1/4" MDF center panel 	<ul style="list-style-type: none"> • Stained doors are 5-piece birch solid wood cope-and-stick construction with a 3/4" (19 mm) thick, 2" wide door frame and 1/4" veneered center panel • Painted doors are 5-piece MDF cope-and-stick with a 3/4" (19 mm) thick, 2" wide door frame and 1/4" MDF center panel
D HINGES	<ul style="list-style-type: none"> • 6-way adjustable soft-close concealed hinges 	<ul style="list-style-type: none"> • 6-way adjustable self-close concealed hinges
E DRAWER FRONTS	<ul style="list-style-type: none"> • 5-piece drawer fronts with 3/4" (19mm) thick frame and 1/4" thick center panel 	<ul style="list-style-type: none"> • 3/4" (19 mm) thick slab drawer fronts
F DRAWERS	<ul style="list-style-type: none"> • 5/8" (18 mm) thick solid wood dovetail drawer boxes with 3/8" thick veneered plywood drawer bottom 	<ul style="list-style-type: none"> • 5/8" (18 mm) thick solid wood dovetail drawer boxes with 3/8" thick veneered plywood drawer bottom
G DRAWER SLIDES	<ul style="list-style-type: none"> • Premium full extension, 100 lb dynamic weight rated, adjustable undermount soft-close slides 	<ul style="list-style-type: none"> • 3/4 extension, 100 lb static weight rated, undermount epoxy slides
H SHELVES	<ul style="list-style-type: none"> • 3/4" (16 mm) thick veneered plywood adjustable shelves – half depth in base cabinets 	<ul style="list-style-type: none"> • 3/4" (16 mm) thick veneered plywood adjustable shelves – half depth in base cabinets
I END PANELS	<ul style="list-style-type: none"> • 1/2" (12 mm) thick plywood end panels with exterior finish to match • UV coated, natural birch interior 	<ul style="list-style-type: none"> • 1/2" (12 mm) thick plywood end panels with exterior finish to match • UV coated, natural birch interior
J TOP/BOTTOM PANELS	<ul style="list-style-type: none"> • 1/2" (12 mm) thick plywood captured top and bottom • UV coated, natural birch interior 	<ul style="list-style-type: none"> • 1/2" (12 mm) thick plywood captured top and bottom • UV coated, natural birch interior
K BACK PANELS	<ul style="list-style-type: none"> • UV coated plywood back panel 	<ul style="list-style-type: none"> • UV coated plywood back panel
L CONSTRUCTION	<ul style="list-style-type: none"> • All plywood cabinet construction • Dovetail / Pocket screw assembly system • 3/4" (19 mm) thick solid wood corner braces • 4-1/2" (114 mm) high toe kick 	<ul style="list-style-type: none"> • All plywood cabinet construction • Dovetail / Pocket screw assembly system • 3/4" (19 mm) thick solid wood corner braces • 4-1/2" (114 mm) high toe kick



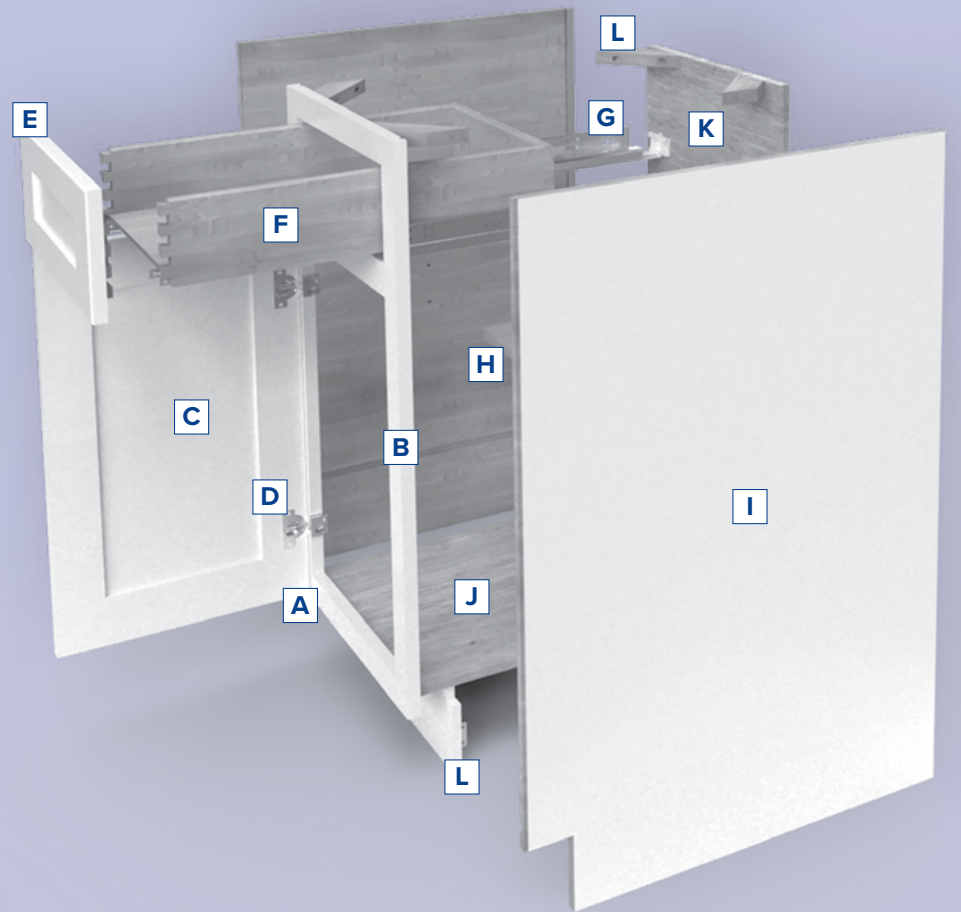
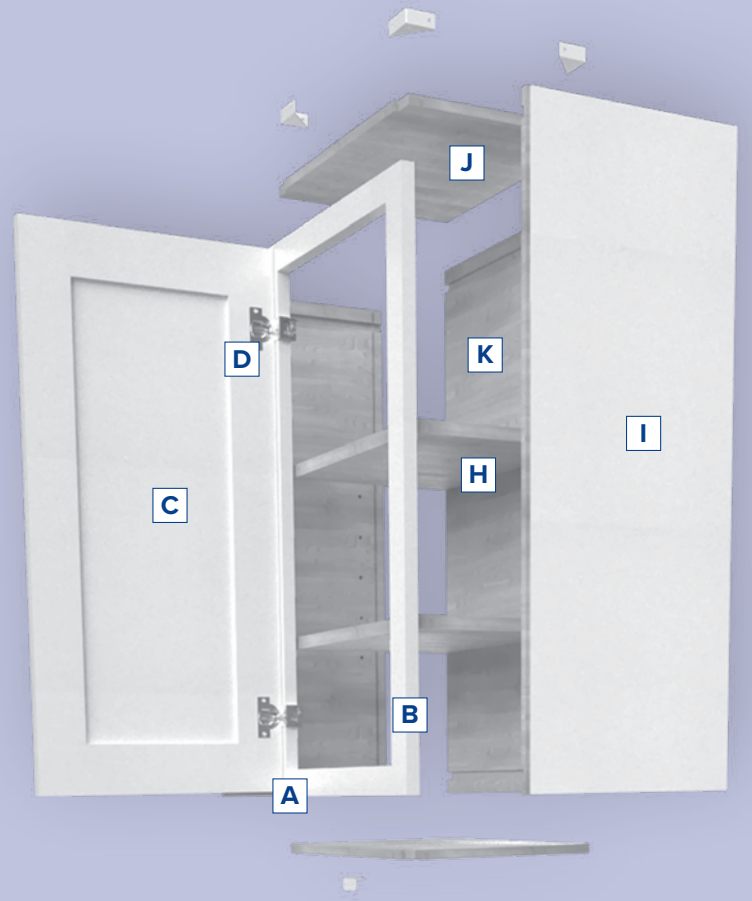

Cabinet Lineup

WALL CABINETS

12" deep except where noted
 42" high wall cabinets will have 3 shelves
 *39" and 42" widths will have a vertical center stile unless otherwise noted

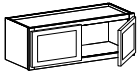

Double Door
 12" Height
 30", 33", 36"
 or *39" Width

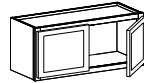

Double Door
 15" Height
 30", 33", 36"
 or *39" Width

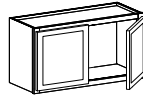

Double Door
 18" Height
 21", 24", 30", 33", 36"
 or *39" Width

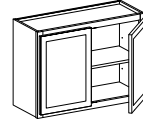

Double Door
 24" Height
 30", 33", 36" or *39" Width

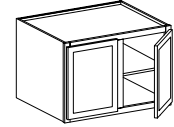

Deep Double Door
 18" or 24" Height • 24" Depth
 36" or *39" Width
 18" Height does not have shelf

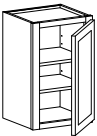

Single Door
 30" Height
 9", 12", 15", 18" or 21" Width

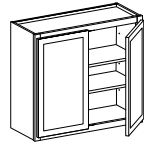

Double Door
 30" Height
 24", 27", 30", 33",
 36", *39" or *42" Width

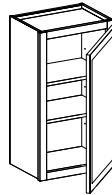

Single Door
 36" Height
 9", 12", 15", 18" or 21" Width

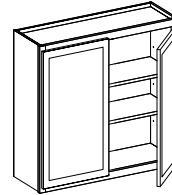

Double Door
 36" Height
 24", 27", 30", 33",
 36", *39" or *42" Width

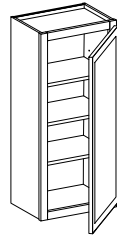

Single Door
 42" Height
 9", 12", 15", 18" or 21" Width

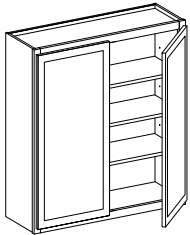

Double Door
 42" Height
 24", 27", 30", 33",
 36", *39" or *42" Width

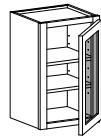

Single & Double Glass Door
 Matching Finish Color Interior
 30" Height
 15", 18", 30" or 36" Width

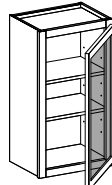

Single & Double Glass Door
 Matching Finish Color Interior
 36" Height
 15", 18", 30" or 36" Width

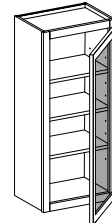

Single & Double Glass Door
 Matching Finish Color Interior
 42" Height
 15", 18", 30" or 36" Width

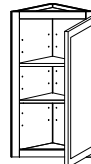

Wall End Single Door
 30", 36" or 42" Height
 12" Width

Glass door wall cabinets only available in the Premier collection

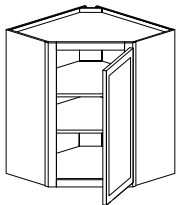

Diagonal Corner
 30", 36" or 42" Height
 12 or 15" Depth
 24" and 27" Width

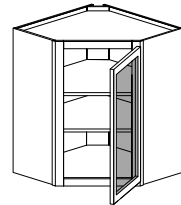

Diagonal Corner Glass Door
 Matching Finish Color Interior
 30", 36" or 42" Height
 12 or 15" Depth
 24" and 27" Width

Glass door wall cabinets only available in the Premier collection

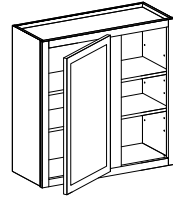

Universal Blind Corner
 30", 36" or 42" Height
 30"-33" Width

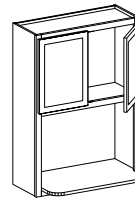

Microwave Wall Cabinet
 Extended Shelf
 36" Height
 30" Width

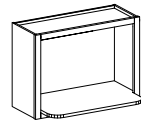

Microwave Wall Cabinet
 Extended Shelf
 18" Height
 30" Width

BASE CABINETS

24" deep, 34-1/2" high
 except where noted

*39" and 42" widths will
 have a vertical center stile
 unless otherwise noted

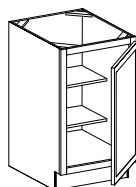

**Full Height
 Single Door**
 9", 12", 15" or 18" Width

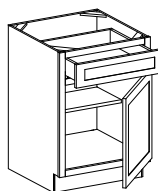

**Single Door
 and Drawer**
 12", 15", 18" or 21" Width

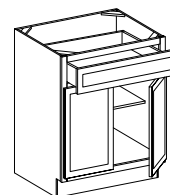

**Double Door and
 Single Drawer**
 24", 27" or 30" Width

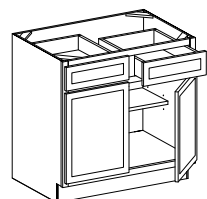

**Double Door and
 Double Drawer**
 33", 36", *39" or *42" Width

2,100 Cabinet Options in Stock for Immediate Delivery

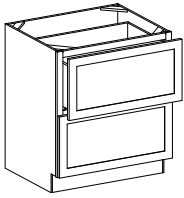

Double Drawer
30" or 36" Width

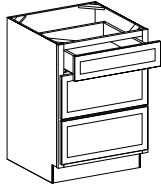

Triple Drawer
12", 15", 18", 21", 24", 30"
or 36" Width

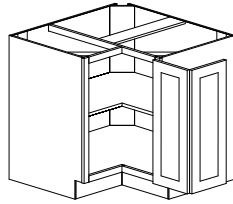

Base Corner Cabinet
33" or 36" Width

(Lazy Susan inserts available)

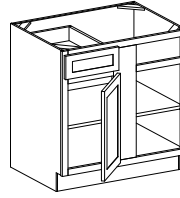

**Universal Blind
Base Corner**
39"-42", 42"-45" or
*45-48" Width

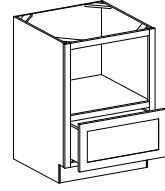

**Microwave Base
Cabinet with Drawer**
30" Width

SINK BASE CABINETS

24" deep, 34-1/2" high
except where noted.

*39" and 42" widths will
have a vertical center stile
unless otherwise noted

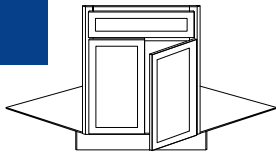

**Corner Sink Front
Double Door**
24" Depth
(2-piece bottom panel)

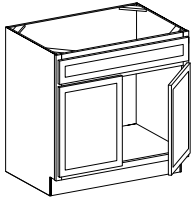

**Sink Base
Double Door**
30", 33", 36" or 39" Width

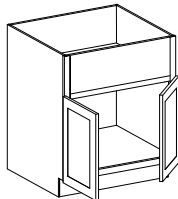

**Farmhouse Sink
Base Double Door**
36" or 39" Width
(No center stile)

TALL CABINETS

24" deep except
where noted.

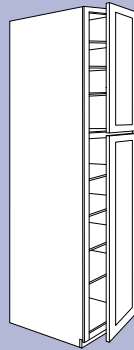

**Utility/Pantry
Single Door**
84", 90" (6 shelves),
or 96" Height (7 shelves)
18" Width

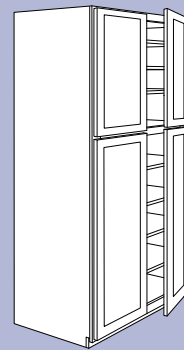

**Utility/Pantry
Double Door**
84", 90" (6 shelves),
or 96" Height (7 shelves)
24" or 30" Width

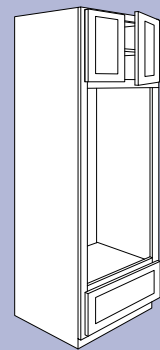

**Oven Double Door,
Single Drawer**
84", 90" or *96" Height
33" Width
*Single shelf in 96" only
(Double Oven Overlay Panel available)

VANITY CABINETS

21" deep, 34-1/2" high
except where noted

*42" widths will have a
vertical center stile

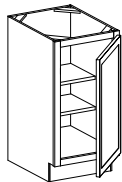

Single Door
12" Width

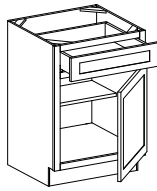

**Single Door
and Drawer**
12", 15" or 18" Width

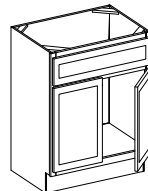

Double Door
24", 27", 30", 33"
or 36" Width

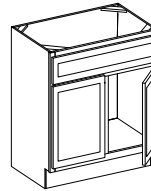

**Double Door
Center Stile**
42" Width

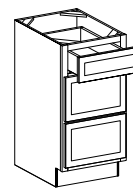

Triple Drawer
12", 15", 18" and
21" Width

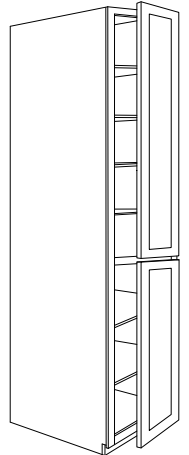

**Linen Single &
Double Door**
84" (6 shelves)
Single - 15" and 18" Width
Double - 24" Width

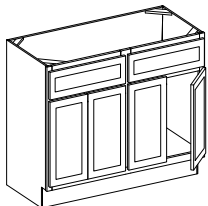

Two Double Door
48" Width

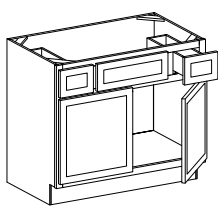

**Double Door and
Double Drawer**
36", 42" or 48" Width

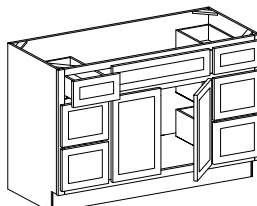

**Double Door and
Six Drawer**
60" Width

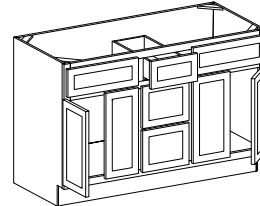

**Two Double Door and
Triple Drawer**
60" Width

Ordering Made Easy

NorthPoint Cabinetry offers 3 convenient methods for easy order placement. We recommend placing orders online for faster processing and delivery, and to easily confirm products are in stock.

1. Online: www.NorthPointCabinetry.com
2. Email: Orders@NorthPointCabinetry.com
3. Fax: (318) 742-9513

Order Placement

Place your online order by visiting www.NorthPointCabinetry.com. Login, select the items you wish to order, and simply checkout.

To order by email or fax, obtain a cabinet order form by logging in to the website, or request a form from a Customer Service team member or your Sales Representative. Submit the completed order form to the email address or fax number listed above. 2020 and ProKitchen material lists are also accepted as long as NorthPoint Cabinetry's item number nomenclature is used.

For questions about your order, call (800) 463-0660. Our friendly customer service agents are available to help you from 7am until 6pm Central Time.

Order Processing

Orders will be ready for pickup two hours after you have received your order confirmation email. Will Call orders are available for pickup at our facilities between the hours of 8am and 4pm local warehouse time. Should you have any questions about picking up your order or need to have the order modified in any way, contact your Customer Service Representative. All requests for returns must be made within 60 days of invoice date. Returns are subject to a 20% restocking fee unless the return is due to Hardware Resources' error or a quality issue.

Returns

To request a Return Goods Authorization (RGA) contact Customer Service.

1. Phone: (800) 463-0660
2. Fax: (318) 742-9513
3. Email: ReturnRequest@HardwareResources.com

Include the item number, quantity and reason for return when requesting an RGA. Items should be in original packaging, unassembled and shipped with care to avoid damage. Items received with damage may not be credited.

In the event that the return is due to an error by Hardware Resources, a return shipping label will be provided. Otherwise, shipments are the Customer's responsibility (including shipping fees) and should be shipped via a method which allows shipment tracking and proof of delivery.

Warranty

Premier Collection

Hardware Resources warrants to the original consumer purchaser that our Premier Cabinetry will be free from unnatural defects in material and workmanship under normal use and proper care for the period of FIVE (5) YEARS from the date of original purchase. This Limited Warranty applies only to the Original Purchaser and is not transferable to any other party.

WARRANTY COVERAGE

Limited 5-Year Warranty on Cabinets to the original purchasing consumer from the date of original purchase that the cabinets will be free from defects in material and workmanship under normal use and proper care. Limited Lifetime Warranty on Drawer Slides and Hinges to the original purchasing consumer as long as they own the product. We warrant that the drawer slides and hinges shall be free from defects in material and workmanship under normal use.

Essentials Collection

Hardware Resources warrants to the original consumer purchaser that our Essentials Cabinetry will be free from unnatural defects in material and workmanship under normal use and proper care for the period of ONE (1) YEAR from the date of original purchase. This Limited Warranty applies only to the Original Purchaser and is not transferable to any other party.

WARRANTY COVERAGE

Limited 1-Year Warranty on Cabinets and on Drawer Slides to the original purchasing consumer from the date of original purchase that the cabinets will be free from defects in material and workmanship under normal use and proper care. Limited Lifetime Warranty on Hinges to the original purchasing consumer as long as they own the product. We warrant that the drawer slides and hinges shall be free from defects in material and workmanship under normal use.

Cabinet Care & Cleaning

- In order to maintain and protect the original beauty of the cabinets, clean at least once a month by gently wiping the surface of the cabinets with a soft, clean, damp cloth. Allow the cabinets to air dry.
- Do NOT use kitchen cloths or sponges that have abrasive surfaces, detergent or grease on them.
- Use common dishwashing liquids (not detergents) to remove grease or soil. Wipe clean with a damp cloth. Dry the cabinet thoroughly.
- Under routine kitchen use, the cabinets around the sink, range, oven, baseboards and dishwasher may become damp with splashes from water or spills. It's important to immediately dry the excess moisture to prevent damage to the finish of the cabinetry.
- Never use cleaners containing bleach, ammonia or abrasives on your cabinetry. These substances will damage the cabinet finish.
- Touch up scratches and dings on cabinetry with a touch-up marker.
- In the event that scratches and dings are still visible after using a touch-up marker, use a filler pencil. Fill in the scratch by rubbing the pencil over the scratched area and wiping away the excess with a soft, clean cloth.
- Do NOT use sandpaper or any other type of abrasive paper or material in attempt to even out a scratch. These abrasives will damage the finish on the cabinet.

